

Monteringsvejledning

Drivhus: Agro Kompakt 2,0

Tekniske specifikationer

Parameter	Værdi
Bredde	200 cm
Højde	200 cm

Illustration



Pakkens indhold (dele)

Nr.	Del	Antal (basis	
1	For- og bagende	2	
2	Buer	3	
5	Start-tværstænger L=1980 mm	5	
6	Samlings-tværstænger L=1960 mm	5	
9	Fastgørelsesben (T-ben)	10	
10	Selvborende skruer 4,2×16 mm	20	
11	Selvborende skruer m. forsænket hoved 3,9×19 mm	90	
12	Skruer m. gummipakning 4,2×25 mm	146	24
13	Bolt 6×50 mm	35	14
15	Møtrik M6	35	14
16	Skive M6	35	14
17	Hængsler	10	-
18	Dørhåndtag	4	-
19	Håndtag til vindue	2	-
20	Gasfjeder	2	-
21	Dørhaspe/lås	4	-
22	Krog	2	-

Figur 1

Vigtige advarsler

- ADVARSEL! Fastgør drivhuset sikkert til underlaget.
- Monter på plant underlag. Kontrollér, at rammens diagonaler er ens.
- Spænd ikke bolte/skruer helt til før hele konstruktionen er samlet.

Montering - illustrationer

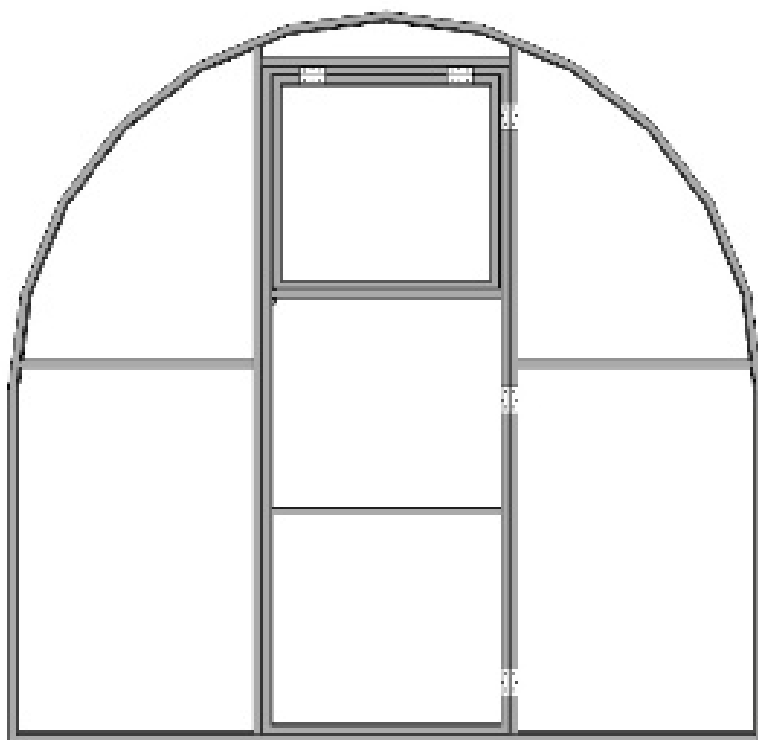

Figur 2

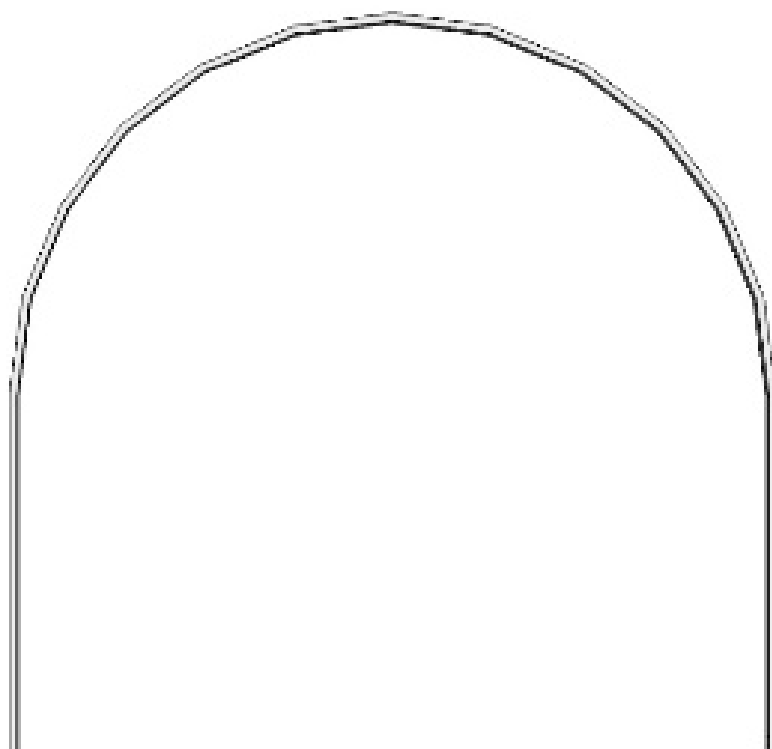

Figur 3

Montering - illustrationer

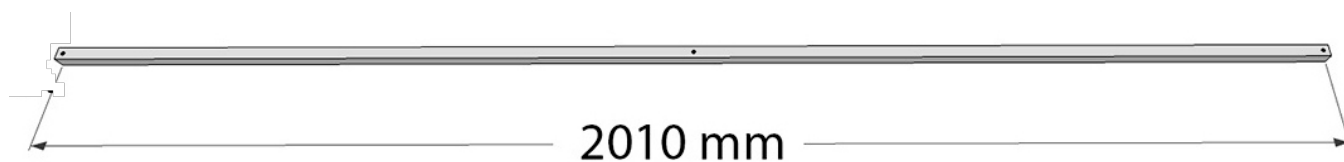

Figur 4



Figur 5

Montering - illustrationer

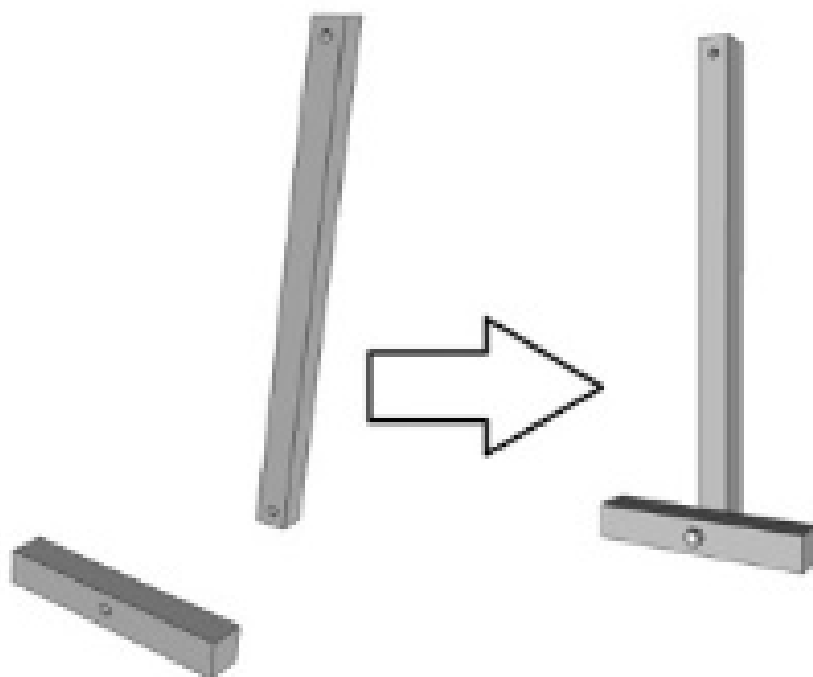

Figur 6



Figur 7

Montering - illustrationer



Figur 8

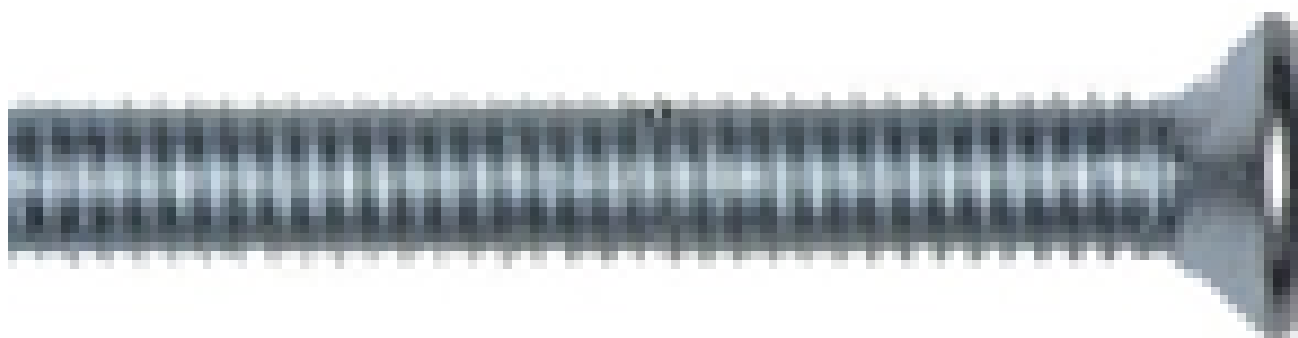

Figur 9

Montering - illustrationer



Figur 10



Figur 11

Montering - illustrationer



Figur 12



Figur 13

Montering - illustrationer



Figur 14

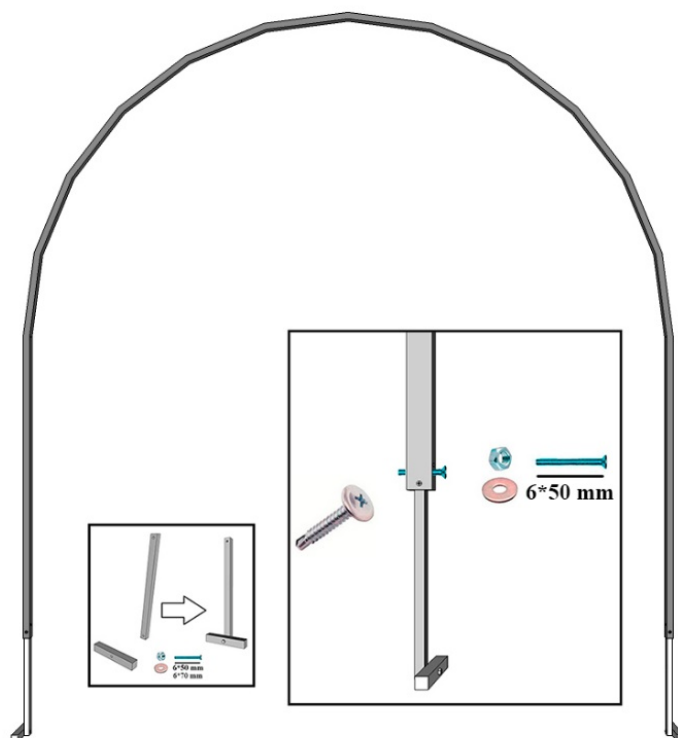

Figur 15

Montering - illustrationer

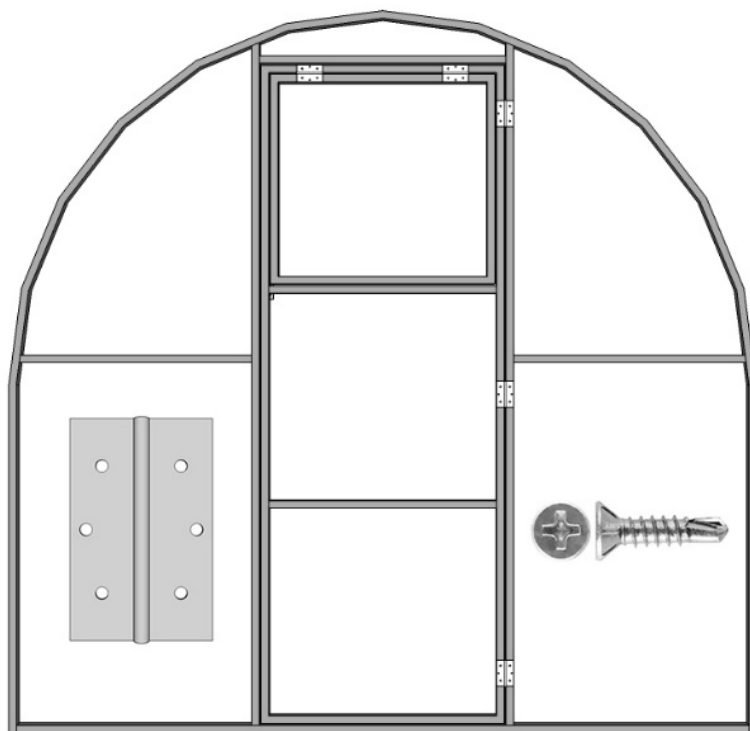

Figur 16

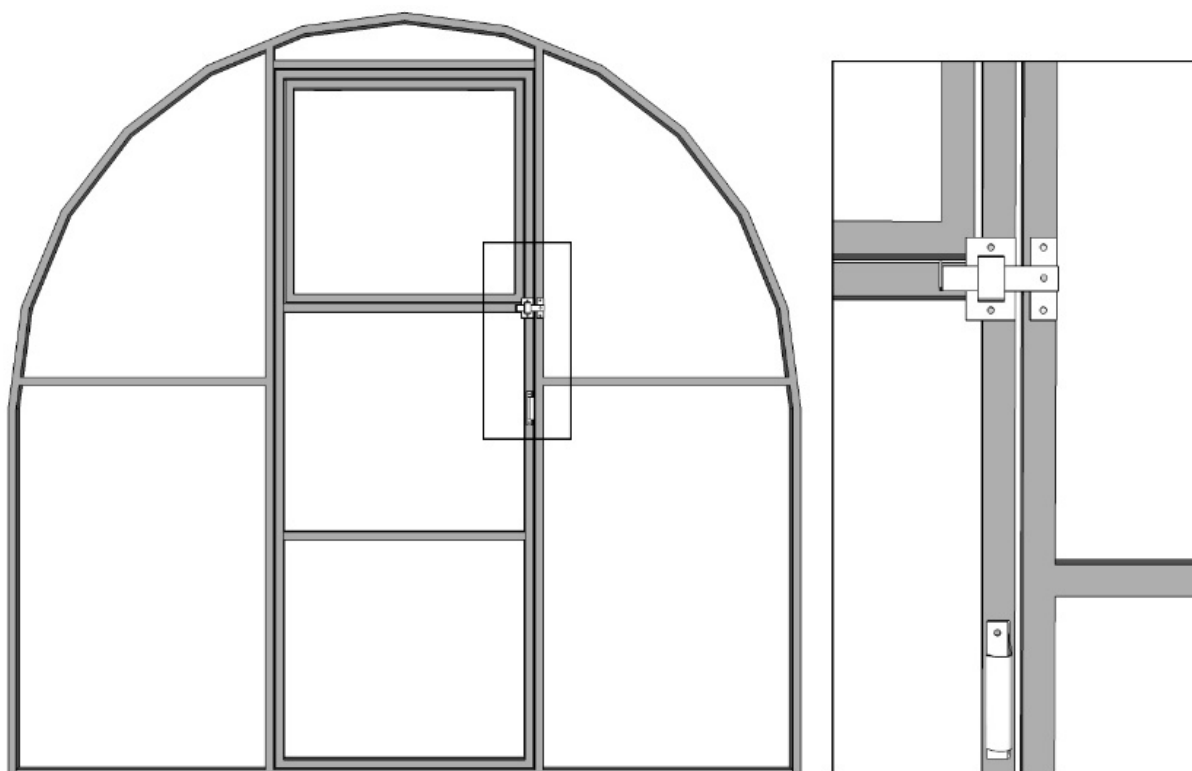

Figur 17

Montering - illustrationer

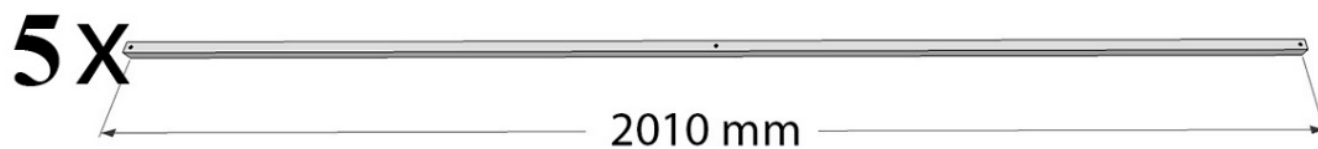

Figur 18

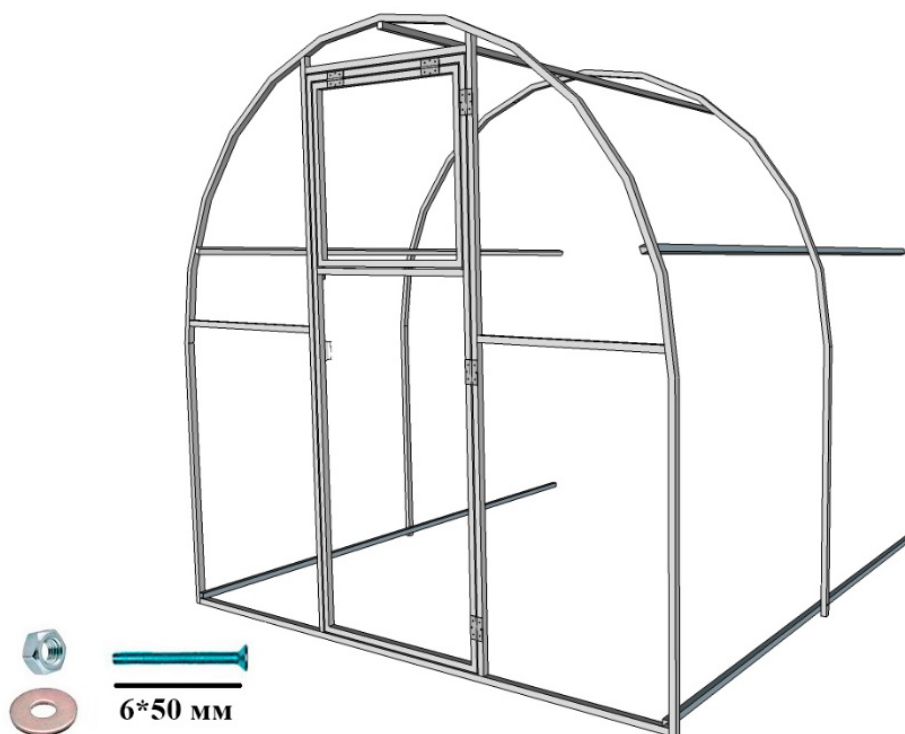

Figur 19

Montering - illustrationer

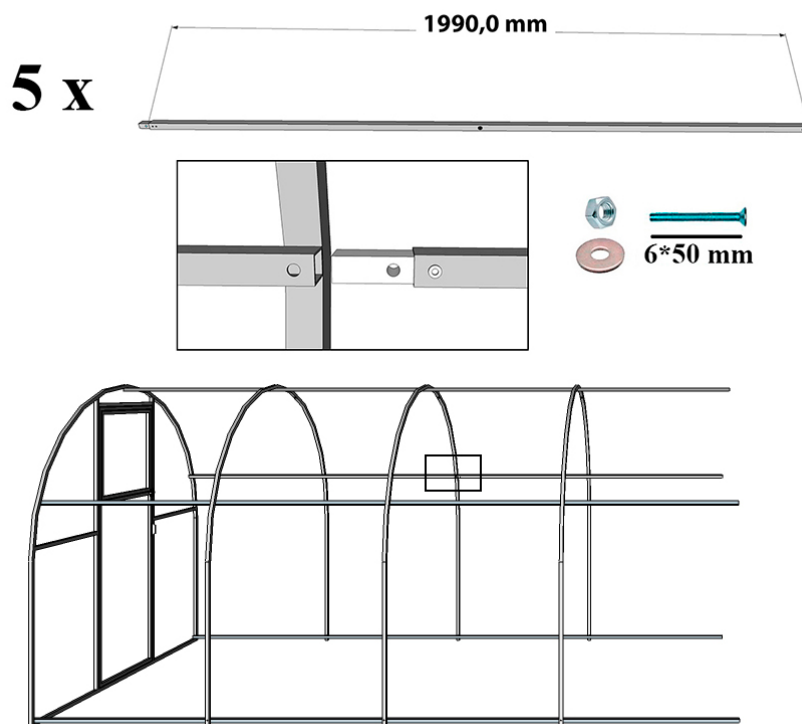

Figur 20

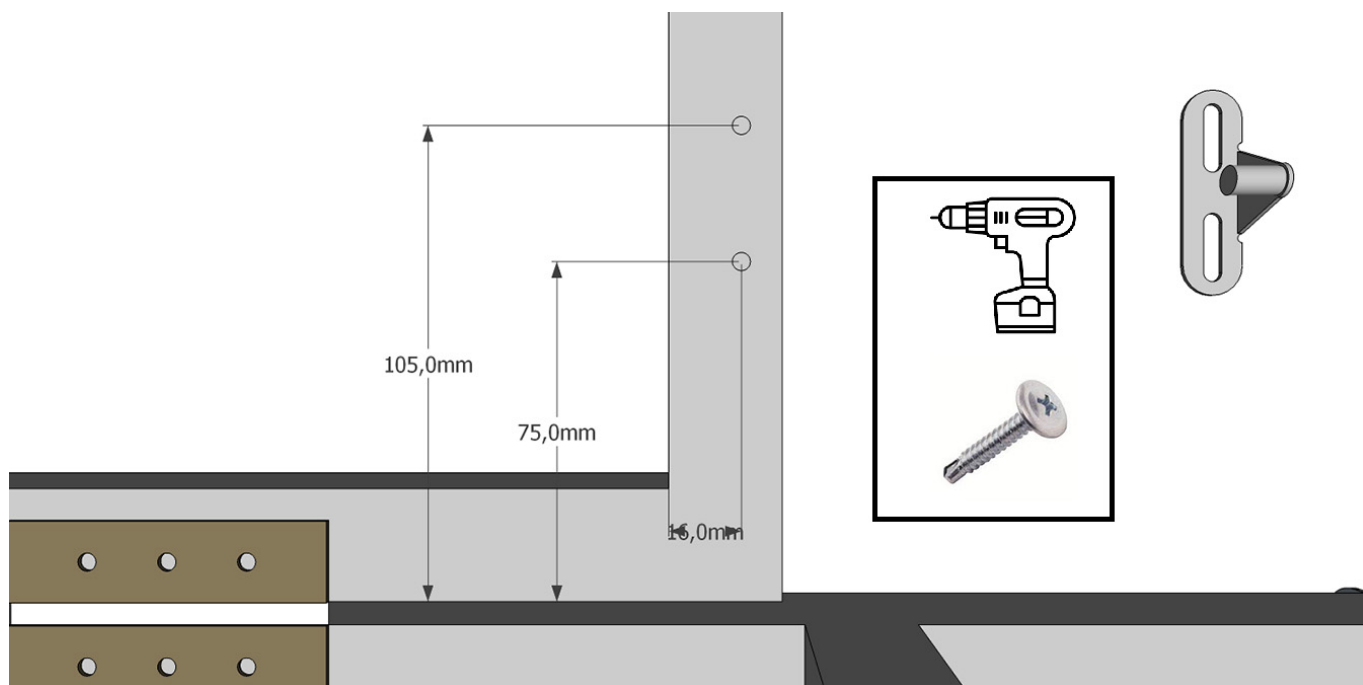

Figur 21

Montering - illustrationer

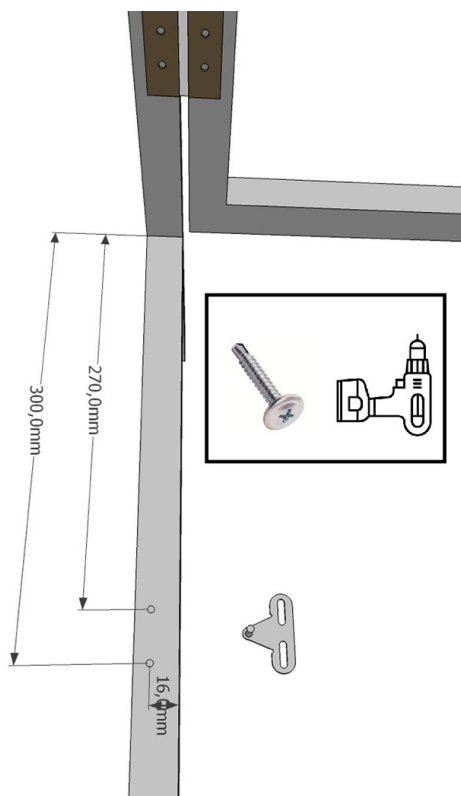

Figur 22



Figur 23

Montering - illustrationer

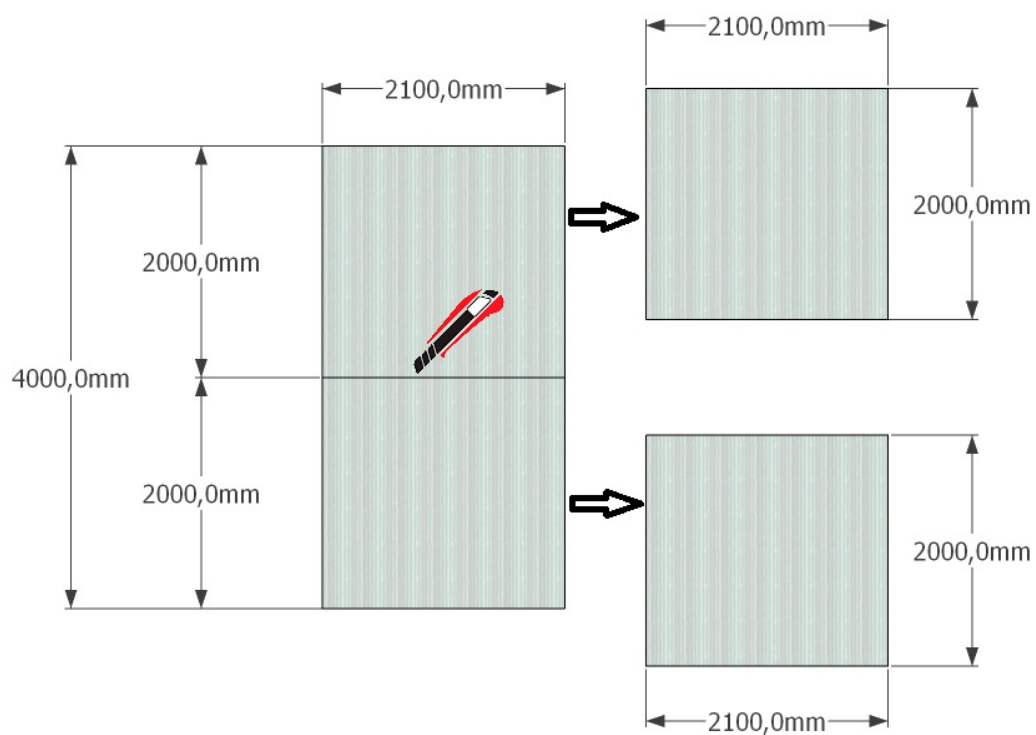

Figur 24



Figur 25

Montering - illustrationer

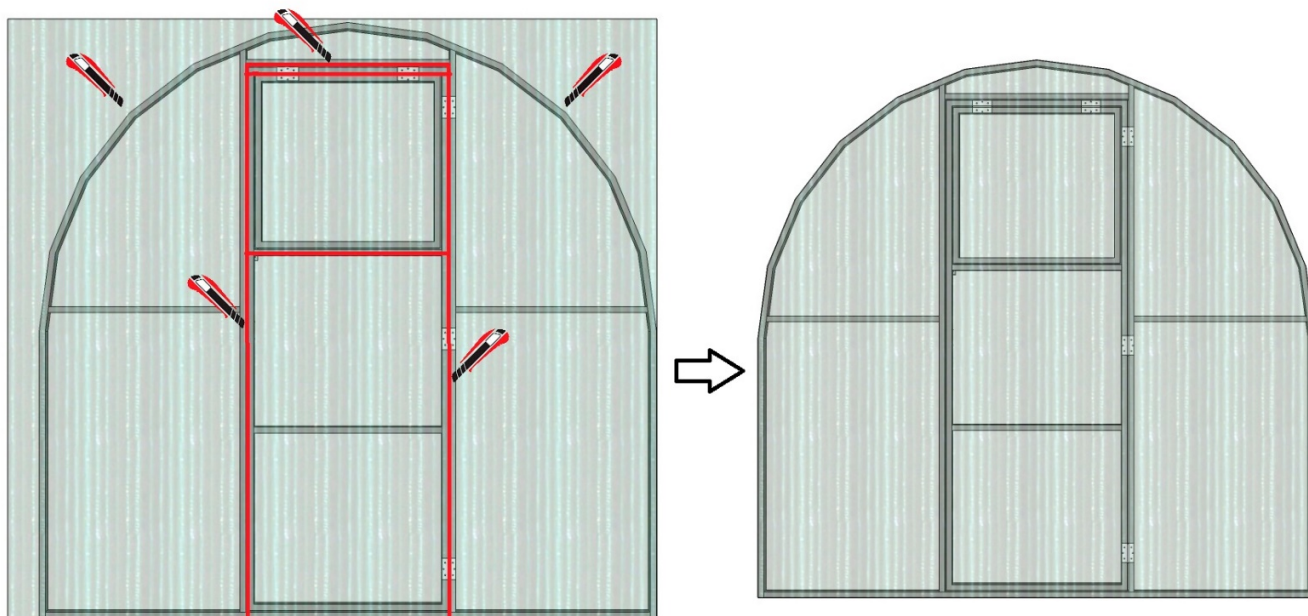

Figur 26

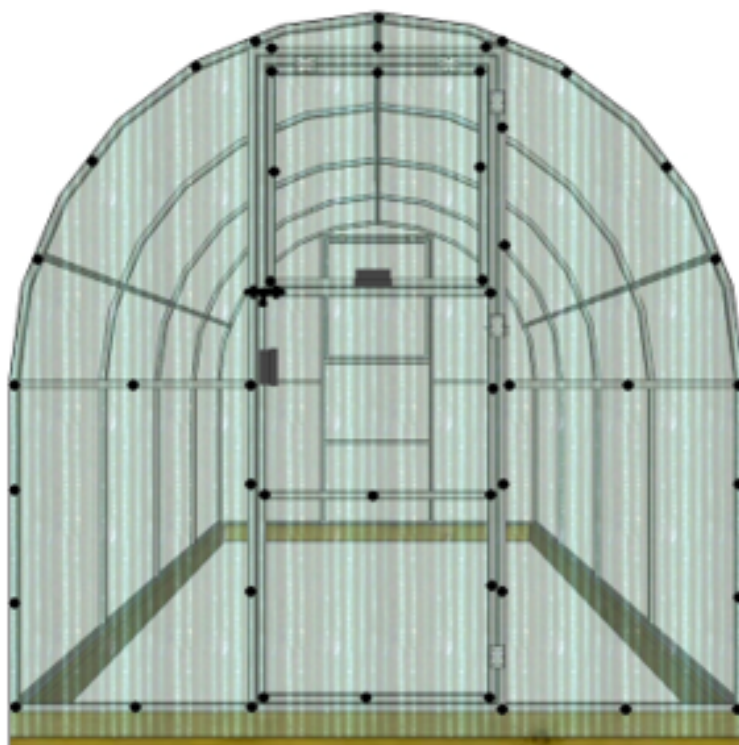

Figur 27

Montering - illustrationer

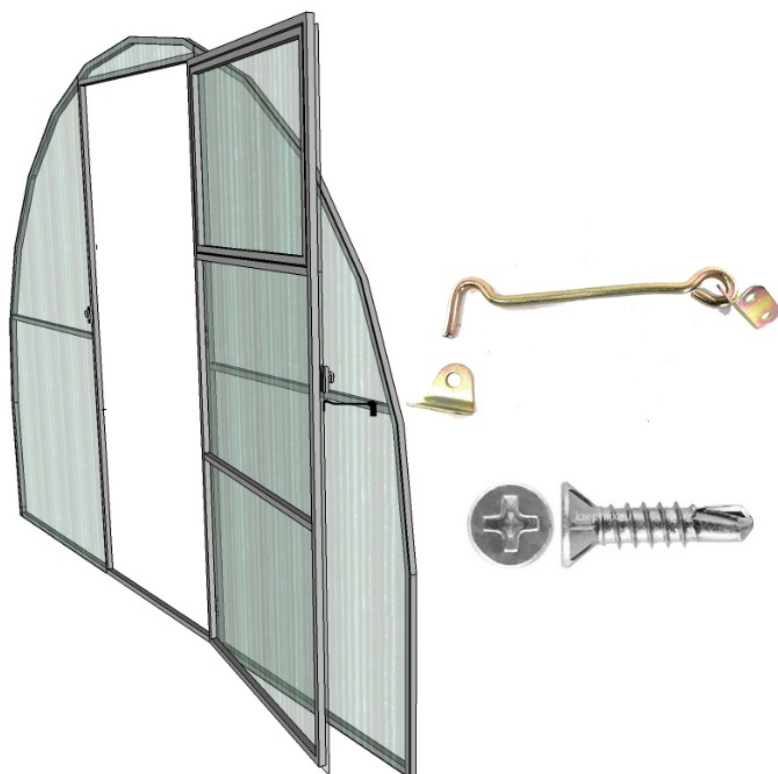

Figur 28

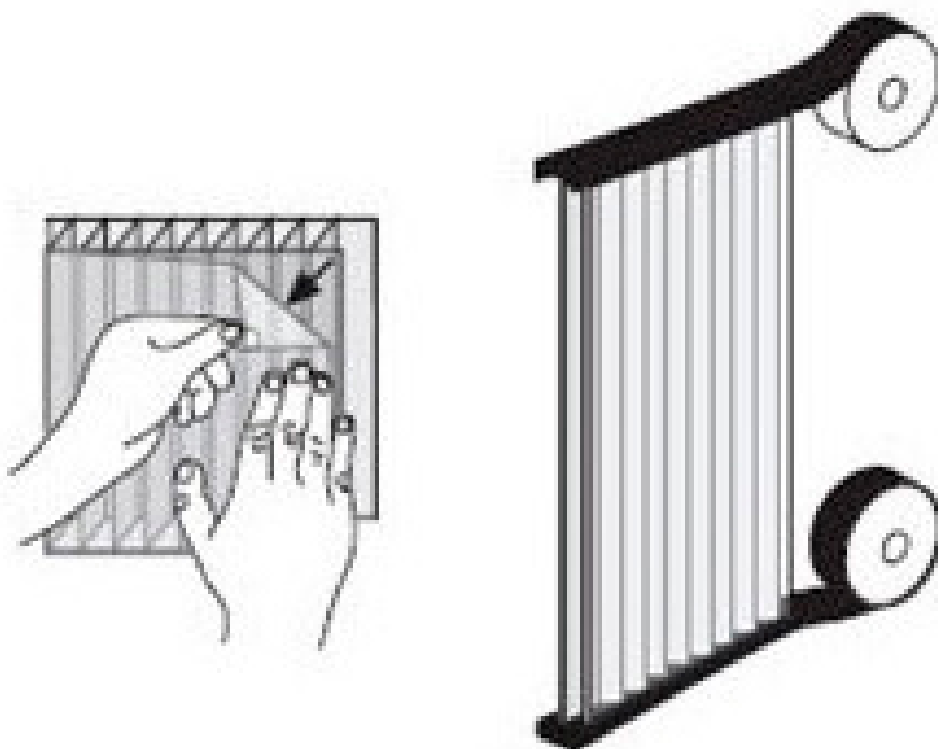

Figur 29

Montering - illustrationer

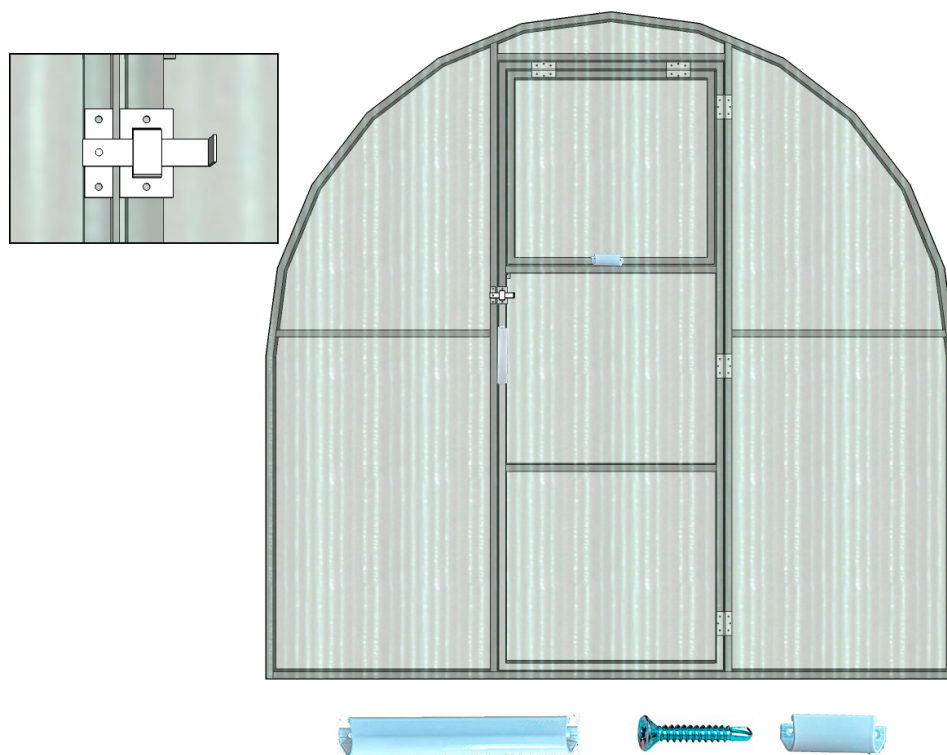

Figur 30

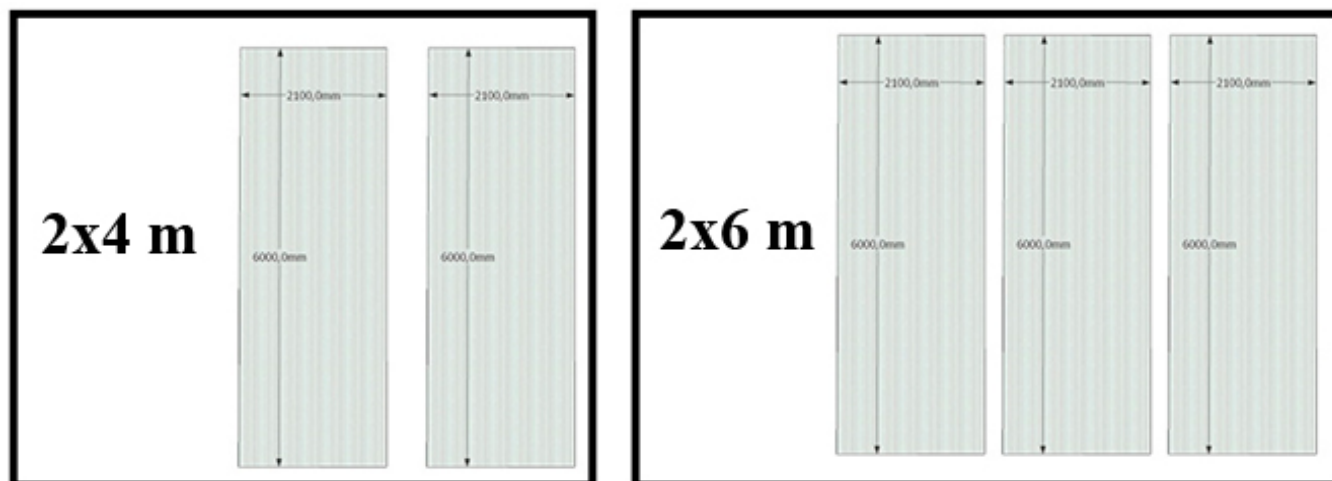

Figur 31

Montering - illustrationer



Figur 32



Figur 33

Montering - illustrationer

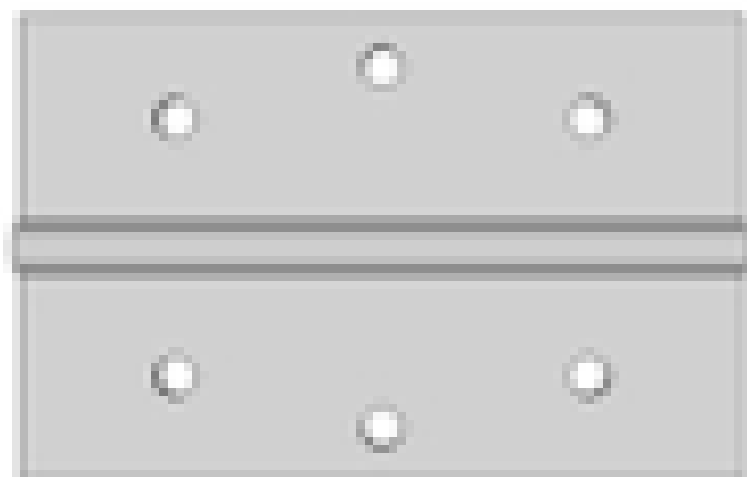

Figur 34



Figur 35

Montering - illustrationer



Figur 36

Bemærkninger (gasfjeder, polycarbonat og drift)

Gasfjeder

Fastgørelsespunkternes mål afhænger af den gasfjeder-model, der følger med drivhuset. De præcise mål findes i gasfjederens emballage.

Polycarbonat (anbefaling)

Polycarbonatets kanaler skal beskyttes mod snavs og insekter. Vi anbefaler at bruge afslutningsprofiler eller montagetape til at lukke enderne.

Drift og sikkerhed

- 1) Efter kraftig vind: efterspænd løse møtrikker eller udskift beslag.
- 2) Placer drivhuset mindst 3 m fra permanente konstruktioner (hegn, træer m.m.).
- 3) Brug ikke åben ild i nærheden af drivhuset.
- 4) Beskyt konstruktionen mod mekanisk påvirkning. Ændr ikke produktets konstruktion.
- 5) Fundament er ikke nødvendigt.
- 6) Galvaniserede profiler kan få en hvidlig overflade ved fugt (normalt).
- 7) Luk polycarbonatpladernes ender med afslutningsprofiler.
- 8) Ventilationsvinduer, tætningstape, afslutningsprofiler, automatisk åbn/luk, vanding, spændebånd, montagearbejde og levering er ikke inkluderet i produktprisen.
- 9) Brug personlige værnemidler ved montering (handsker, briller osv.).
- 10) OBS! Konstruktionen kan have skarpe kanter/hjørner.
- 11) Brug ikke svovlrøgpatroner eller andre kemikalier, der kan skade metal- og plastdele.